

solopacks

· CANAPÉS Y COLCHONES SELECCIONADOS ·



INDICACIONES PARA REALIZAR UN PEDIDO

- No olvide reflejar en su pedido el modelo, medidas y acabados del producto. Así como especificar si lleva un colchón pesado.
- Los canapés se envían por defecto con apertura frontal y altura de serie, si no se especifica lo contrario.
- Devoluciones por causas ajenas a fábrica o error en el pedido, consultar cargo con fábrica.
- **NO SE ADMITEN CAMBIOS O DEVOLUCIONES EN PRODUCTOS TAPIZADOS, MEDIDAS Y ACABADOS ESPECIALES.**
- Dispone de 7 días para reclamar daños en el producto. Pasado este plazo, fábrica efectuará el cargo correspondiente.
- Medidas especiales consulte con fábrica.

CARGO POR TRANSPORTE

- En pedidos con valor inferior a 130 euros, se cargará en factura 10 euros en concepto de gastos de transporte.
- Fábrica NO SE RESPONSABILIZA DE ADJUNTAR PEDIDOS para evitar dicho cargo.



solopecks

· canapés y colchones seleccionados ·

Packs



Pack 01
Maurice+Base Tapizada
p. 6



Pack 02
Maurice+Canapé Ares
p. 7



Pack 03
Camille+Base Tapizada
p. 8



Pack 04
Camille+Canapé Ares
p. 9



Pack 05
Camille+Canapé Goya
p. 10



Pack 06
Aura+Bancada Menorca
p. 11



Pack 07
Aura+Canapé Filipo
p. 12



Pack 08
Aura+Canapé Goya
p. 13



Pack 09
Maurice+Base Ninfa
p. 15



Pack 10
Thiago+Bancada Menorca
p. 16



Pack 11
Thiago+Canapé Filipo
p. 17



Pack 12
Thiago+Canapé Goya
p. 18



Pack 13
Thiago+Canapé Tucán
p. 19



Pack 14
Thiago+Canapé Ninfa
p. 20



Pack 15
Eric+Canapé Tucán
p. 21



Pack 16
Eric+Canapé Teruel
p. 22



Pack 17
Eric+Canapé Condor
p. 23



Pack 18
Eric+Canapé Estambul
p. 24



Pack 19
Eric+Canapé Elena
p. 25



Pack 20
Bella+Canapé Tucán
p. 26



Pack 21
Bella+Canapé Teruel
p. 27



Pack 22
Bella+Canapé Condor
p. 28



Pack 23
Bella+Canapé Estambul
p. 29



Pack 24
Bella+Canapé Elena
p. 31

Packs

Packs articulados



Pack 25
Ariel+Base articulada
p. 32



Pack 26
Ariel+Canapé Goya
p. 33



Pack 27
Ariel+Canapé Estambul
p. 34



Pack 28
Ariel+Canapé Elena
p. 35



Pack 29
Alana+Base articulada
p. 36



Pack 30
Alana+Canapé Goya
p. 37



Pack 31
Alana+Canapé Estambul
p. 38



Pack 32
Alana+Canapé Elena
p. 39

Colchones



Maurice
p. 40-41



Camille
p. 42-43



Aura
p. 44-45



Thiago
p. 46-47



Alana
p. 48-49



Eric
p. 50-51



Bella
p. 52-53



Ariel
p. 54-55

Pack 01

COLCHÓN MAURICE
BASE TAPIZADA

Colchón MAURICE, núcleo HR con visco. Pág. 40
Base TAPIZADA 3D blanco, con patas cilindro blanco. Patas incluidas.



↑ 26cm. ↓
Grosor colchón

HR
Núcleo HR Ultra Plus

GRADO DE TRANSPIRACIÓN ●●●○○
GRADO DE FIRMEZA ●●●○○



PACK 01							
	80/90	105	120/135	140/150	160	180	200
180/190	422	463	551	595	640	739	925
200	454	498	590	639	695	801	996

Tablero multiperforado DE SERIE

Tejido antideslizante DE SERIE

Base partida +95 pts.

Grosor 5 cm.



Pata CUADRADA



Pata CILINDRO

Pack 02

COLCHÓN MAURICE
CANAPÉ ARES

Colchón MAURICE, núcleo HR con visco. Pág. 40
Canapé ARES, arcón de madera acabado artic, tapa tapizada 3D blanco.

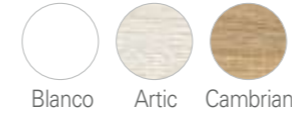

↑ 26cm. ↓
Grosor colchón

HR
Núcleo HR Ultra Plus

GRADO DE TRANSPIRACIÓN ●●●○○
GRADO DE FIRMEZA ●●●○○

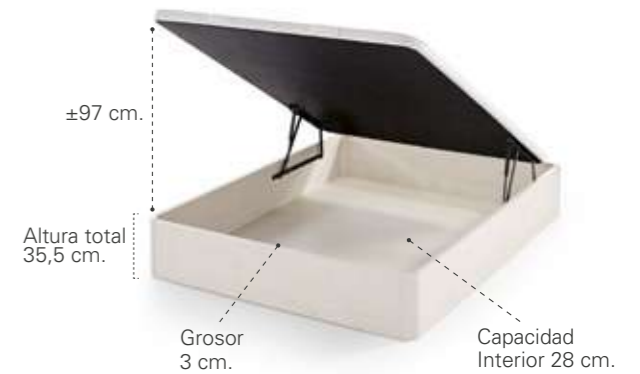

PACK 02					
	80/90	105	135	140/150	160
180/190	579	627	725	764	860
200	616	671	777	823	911

A suelo DE SERIE

Tablero multiperforado DE SERIE

Tejido antideslizante DE SERIE

Pack 03

COLCHÓN CAMILLE BASE TAPIZADA

Colchón **CAMILLE**, núcleo de carcasa de muelles ensacado con visco. [Info](#) Pág. 42
Base **TAPIZADA** 3D blanco, con patas cilindro blanco. Patas incluidas.



↑ **26cm.** ↓
Grosor colchón

↑ **26cm.** ↓
Grosor colchón

Muelle ensacado 2 mm.

GRADO DE TRANSPIRACIÓN ●●●○

GRADO DE FIRMEZA ●●●○



PACK 03							
	80/90	105	120/135	140/150	160	180	200
180/190	431	471	562	601	647	747	933
200	463	507	603	645	701	809	1005

Tablero multiperforado DE SERIE

Tejido antideslizante DE SERIE

Base partida +95 ptos.

Grosor 5 cm.



Pata CUADRADA



Pata CILINDRO

Pack 04

COLCHÓN CAMILLE CANAPÉ ARES

Colchón **CAMILLE**, núcleo de carcasa de muelles ensacado con visco. [Info](#) Pág. 42
Canapé **ARES**, arcón de madera acabado artic, tapa tapizada 3D blanco.

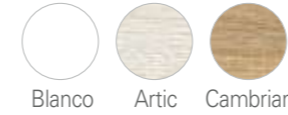

↑ **26cm.** ↓
Grosor colchón

↑ **26cm.** ↓
Grosor colchón

Muelle ensacado 2 mm.

GRADO DE TRANSPIRACIÓN ●●●○

GRADO DE FIRMEZA ●●●○

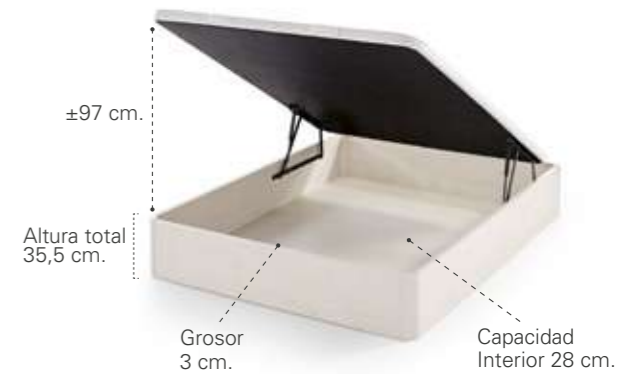

PACK 04					
	80/90	105	135	140/150	160
180/190	588	636	736	770	866
200	626	680	789	829	918

A suelo DE SERIE

Tablero multiperforado DE SERIE

Tejido antideslizante DE SERIE

Pack 05

COLCHÓN **CAMILLE**
CANAPÉ **GOYA**

Colchón **CAMILLE**, núcleo de carcasa de muelles ensacado con visco. Info Pág. 42
CANAPÉ **GOYA**, arcón de madera acabado artíc, tapa tapizada 3D blanco.



↑ **26cm.** ↓
Grosor colchón

Muelle ensacado 2 mm.

GRADO DE **TRANSPIRACIÓN** ●●●○

GRADO DE **FIRMEZA** ●●●○



PACK 05					
	80/90	105	120/135	140/150	160
180/190	649	701	806	851	910
200	686	742	856	904	967

TAPA PARTIDA Y DOBLE PISTÓN DE SERIE	
180	200
1127	1240
1192	1298

- Bisagra doble pistón +35 ptos.
- A suelo DE SERIE
- Tablero multiperforado DE SERIE
- Tejido antideslizante DE SERIE
- Tapa partida +125 ptos.
- Con patas +30 ptos.

Pack 06

COLCHÓN **AURA**
Bancada **MENORCA**

Colchón **AURA**, núcleo HR con visco. Info Pág. 44
Bancada **MENORCA** tapizado Brunei 5, patas cilindro natural.

↑ **28cm.** ↓
Grosor colchón

Núcleo HR Ultra Plus

GRADO DE **TRANSPIRACIÓN** ●●●○

GRADO DE **FIRMEZA** ●●●○



Pata madera cilindro o cuadrada

Pata metálica cromo plata DE SERIE

PACK 06 - Acabado Serie 1					
	80/90	105	135	140/150	160
180/190	571	623	747	802	918
200	609	666	797	858	980

INCREMENTO SOBRE Serie 1	
S2	+ 15
S3	+ 25
S4	+ 40

- Tablero multiperforado DE SERIE
- Tejido antideslizante DE SERIE



Pata CUADRADA



Pata CILINDRO

Pack 07 | COLCHÓN AURA CANAPÉ FILIPO

Colchón **AURA**, núcleo HR con visco. info Pág. 44
Canapé **FILIPO**, arcón de madera acabado cambrian, tapa tapizada 3D crudo.

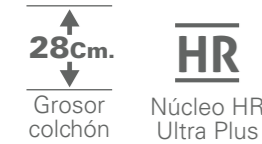
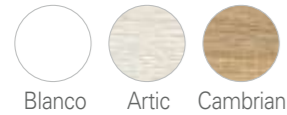

GRADO DE TRANSPIRACIÓN ●●●●○
GRADO DE FIRMEZA ●●●●○

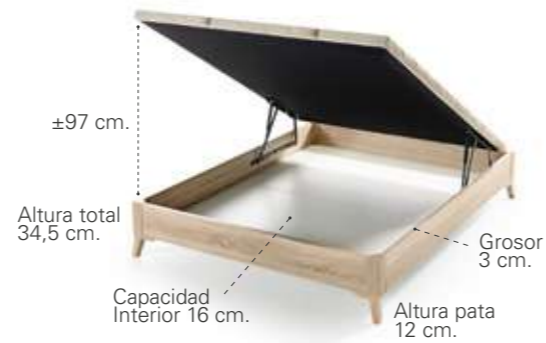

OPCIÓN PATAS pág. 56

PACK 07							
	80/90	105	120/135	140/150	160	180	200
180/190	697	759	877	938	1018	1181	1301
200	742	806	933	1005	1085	1241	1398

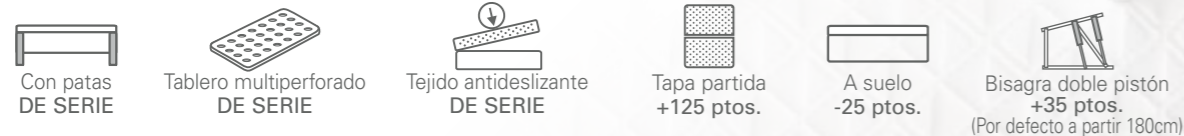

Pack 08 | COLCHÓN AURA CANAPÉ GOYA

Colchón **AURA**, núcleo HR con visco. info Pág. 44
Canapé **GOYA**, arcón de madera acabado artic, tapa tapizada 3D blanco.

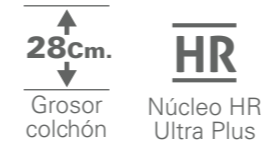

GRADO DE TRANSPIRACIÓN ●●●●○
GRADO DE FIRMEZA ●●●●○



PACK 08						TAPA PARTIDA Y DOBLE PISTÓN DE SERIE	
	80/90	105	120/135	140/150	160	180	200
180/190	712	773	892	953	1023	1260	1390
200	755	821	951	1017	1092	1339	1468





Pack 09 | COLCHÓN AURA CANAPÉ NINFA

Colchón **AURA**, núcleo HR con visco. Pág. 44
Canapé **NINFA**, arcón tapizado Anthology 2. Pata Tación negro mate.

28cm.
Grosor colchón

HR
Núcleo HR Ultra Plus

GRADO DE TRANSPIRACIÓN

GRADO DE FIRMEZA



TIRADOR METÁLICO NEGRO MATE O CROMO PLATA
OPCIÓN PATAS pág. 56

PACK 09 - Acabado Serie 1							
	80/90	105	120/135	140/150	160	180	200
180/190	789	842	966	1028	1096	1245	1428
200	826	886	1015	1081	1158	1315	1501

INCREMENTO SOBRE Serie 1	
S2	+ 20
S3	+ 60
S4	+ 80

Con patas DE SERIE

Bisagra doble pistón +35 pts. (Por defecto a partir 180cm)

Tablero multiperforado DE SERIE

Tapa partida +125 pts.

Tejido antideslizante DE SERIE

A suelo -25 pts.

Pack 10

COLCHÓN **THIAGO**
BANCADA **MENORCA**

Colchón **THIAGO**, núcleo de carcasa de muelles ensacado con visco. [Info](#) Pág. 46
Bancada **MENORCA** tapizado Brunei 5, patas cilindro natural.

↑
28cm.
↓
Grosor colchón

Muelle ensacado 2 mm.

Tejido NOAS COOL

GRADO DE TRANSPIRACIÓN ●●●●●
GRADO DE FIRMEZA ●●●●○



Pata madera cilindro o cuadrada



Pata metálica cromo plata DE SERIE

PACK 10 - Acabado Serie 1					
	80/90	105	120/135	140/150	160
180/190	580	629	764	813	931
200	618	673	816	871	994

INCREMENTO SOBRE Serie 1	
S2	+ 15
S3	+ 25
S4	+ 40



Pata CUADRADA



Pata CILINDRO



Pack 11

COLCHÓN **THIAGO**
CANAPÉ **FILIPO**

Colchón **THIAGO**, núcleo de carcasa de muelles ensacado con visco. [Info](#) Pág. 46
Canapé **FILIPO**, arcón de madera acabado cambrian, tapa tapizada 3D crudo.

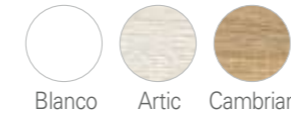

↑
28cm.
↓
Grosor colchón

Muelle ensacado 2 mm.

Tejido NOAS COOL

GRADO DE TRANSPIRACIÓN ●●●●●
GRADO DE FIRMEZA ●●●●○

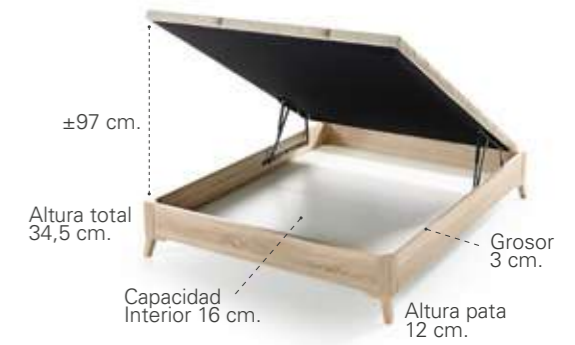

OPCIÓN PATAS pág. 56

PACK 11							
	80/90	105	120/135	140/150	160	180	200
180/190	706	765	894	949	1030	1198	1318
200	752	812	951	1017	1099	1258	1408

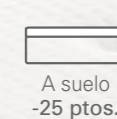

Pack 12 | COLCHÓN THIAGO CANAPÉ GOYA

Colchón **THIAGO**, núcleo de carcasa de muelles ensacado con visco. [Info](#) Pág. 46
Canapé **GOYA**, arcón de madera acabado artic, tapa tapizada 3D blanco.



GRADO DE TRANSPIRACIÓN ●●●●●

GRADO DE FIRMEZA ●●●●○



PACK 12					
	80/90	105	120/135	140/150	160
180/190	721	778	909	965	1036
200	765	827	970	1029	1106

TAPA PARTIDA Y DOBLE PISTÓN DE SERIE	
180	200
1275	1407
1355	1487



Pack 13 | COLCHÓN THIAGO CANAPÉ TUCÁN

Colchón **THIAGO**, núcleo de carcasa de muelles ensacado con visco. [Info](#) Pág. 46
Canapé **TUCÁN**, arcón de madera acabado bruma, tapa tapizada 3D crudo.

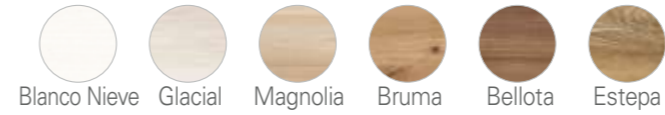

GRADO DE TRANSPIRACIÓN ●●●●●

GRADO DE FIRMEZA ●●●●○



OPCIÓN PATAS pág. 56

PACK 13							
	80/90	105	120/135	140/150	160	180	200
180/190	726	780	914	974	1043	1189	1330
200	763	824	970	1033	1107	1263	1410



Pack 14 | COLCHÓN THIAGO CANAPÉ NINFA

Colchón **THIAGO**, núcleo de carcasa de muelles ensacado con visco. [Info](#) Pág. 46
Canapé **NINFA**, arcón tapizado Anthology 2. Pata Tacon negro mate.

↑
28cm.
↓
Grosor colchón

Muelle ensacado 2 mm.

Tejido NOAS COOL

GRADO DE TRANSPIRACIÓN ●●●●●

GRADO DE FIRMEZA ●●●●○



TIRADOR METÁLICO NEGRO MATE O CROMO PLATA
OPCIÓN PATAS pág. 56

PACK 14 - Acabado Serie 1								INCREMENTO SOBRE Serie 1	
	80/90	105	120/135	140/150	160	180	200	S2	+ 20
180/190	797	848	983	1039	1108	1260	1498	S3	+ 60
200	836	892	1034	1093	1171	1331	1648	S4	+ 80

Bisagra doble pistón +35 ptos.
(Por defecto a partir 180cm)

Con patas DE SERIE

Tablero multiperforado DE SERIE

Tejido antideslizante DE SERIE

Tapa partida +125 ptos.

A suelo -25 ptos.

Pack 15 | COLCHÓN ERIC CANAPÉ TUCÁN

Colchón **ERIC**, núcleo de carcasa de muelles ensacado con visco. [Info](#) Pág. 50
Canapé **TUCÁN**, arcón de madera acabado bruma, tapa tapizada 3D crudo.

Blanco Nieve Glacial Magnolia Bruma Bellota Estepa

↑
30cm.
↓
Grosor colchón

Muelle ensacado 2 mm.

GRADO DE TRANSPIRACIÓN ●●●●○

GRADO DE FIRMEZA ●●●●○



OPCIÓN PATAS pág. 56

PACK 15							
	80/90	105	120/135	140/150	160	180	200
180/190	763	823	956	1011	1084	1236	1389
200	803	870	1017	1074	1151	1315	1470

Tirador EMBUTIDO DE SERIE

Con patas DE SERIE

Bisagra doble pistón +35 ptos.
(Por defecto a partir 180cm)

Tablero multiperforado DE SERIE

Tapa partida +125 ptos.

Tejido antideslizante DE SERIE

A suelo -25 ptos.

Pack 16 | COLCHÓN ERIC CANAPÉ TERUEL

Colchón **ERIC**, núcleo de carcasa de muelles ensacado con visco. [Info](#) Pág. 50
Canapé **TERUEL**, arcón de madera acabado blanco, tapa tapizada 3D blanco.

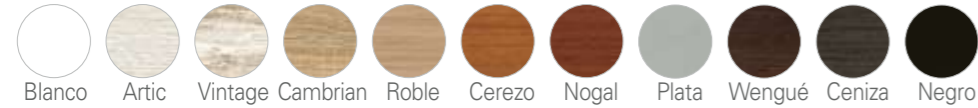

↑ **30cm.** ↓
Grosor colchón

Muelle ensacado 2 mm.

GRADO DE TRANSPIRACIÓN ●●●●○
GRADO DE FIRMEZA ●●●●●



PACK 16							
	80/90	105	120/135	140/150	160	180	200
180/190	770	827	951	1001	1064	1216	1346
200	815	877	1012	1064	1144	1298	1440

Bisagra doble pistón +35 ptos. (Por defecto a partir 180cm)

A suelo DE SERIE

Tablero multiperforado DE SERIE

Tejido antideslizante DE SERIE

Tapa partida +125 ptos.

Con patas SIN CARGO

Pack 17 | COLCHÓN ERIC CANAPÉ CONDOR

Colchón **ERIC**, núcleo de carcasa de muelles ensacado con visco. [Info](#) Pág. 50
Canapé **CONDOR**, arcón de madera acabado bellota, tapa tapizada 3D chocolate.

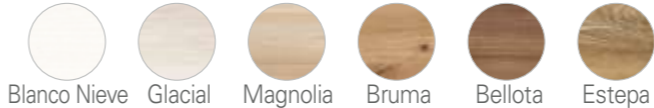

↑ **30cm.** ↓
Grosor colchón

Muelle ensacado 2 mm.

GRADO DE TRANSPIRACIÓN ●●●●○
GRADO DE FIRMEZA ●●●●●



PACK 17							
	80/90	105	120/135	140/150	160	180	200
180/190	779	845	975	1031	1105	1258	1420
200	821	892	1036	1094	1173	1338	1502

Tirador EMBUTIDO DE SERIE

A suelo DE SERIE

Bisagra doble pistón +35 ptos. (Por defecto a partir 180cm)

Tablero multiperforado DE SERIE

Tapa partida +125 ptos.

Tejido antideslizante DE SERIE

Pack 18

COLCHÓN **ERIC**
CANAPÉ **ESTAMBUL**

Colchón **ERIC**, núcleo de carcasa de muelles ensacado con visco. Info Pág. 50
Canapé **ESTAMBUL**, arcón de madera acabado blanco, tapa tapizada 3D blanco.

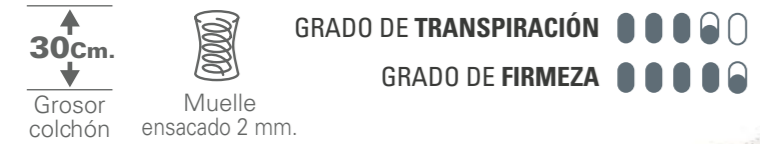
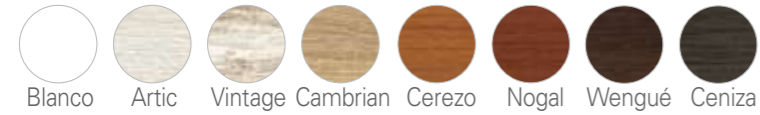

PACK 18					
	80/90	105	120/135	140/150	160
180/190	785	844	994	1042	1145
200	828	896	1051	1104	1209

PACK 18 DUO			
	160	180	200
180/190	1440	1547	1657
200	1512	1625	1766



Pack 19

COLCHÓN **ERIC**
CANAPÉ **ELENA**

Colchón **ERIC**, núcleo de carcasa de muelles ensacado con visco. Info Pág. 50
Canapé **ELENA**, arcón tapizado Tiago plata, tapa 3D.

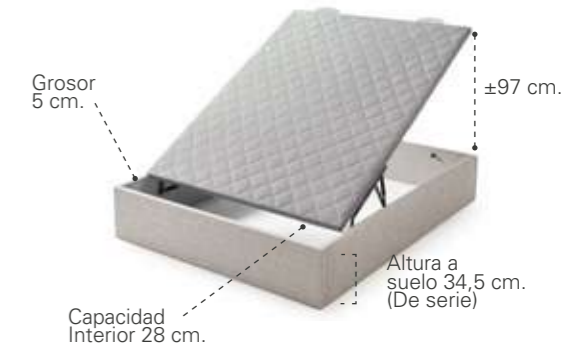
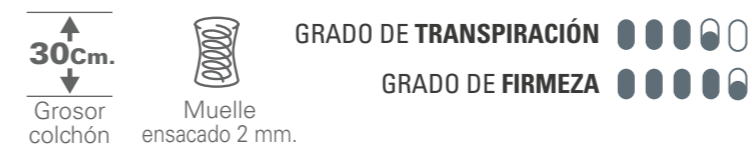

TIRADOR EN CROMO PLATA DE SERIE.
OPCIONAL EN NEGRO MATE.

PACK 19 - ACABADO SERIE 1							
	80/90	105	120/135	140/150	160	180	200
180/190	839	903	1040	1091	1173	1330	1469
200	881	947	1095	1151	1237	1404	1580

INCREMENTO SOBRE Serie 1	
S2	+ 35
S3	+ 75
S4	+ 105



Pack 20

COLCHÓN **BELLA**
CANAPÉ **TUCÁN**

Colchón **BELLA**, núcleo de carcasa de muelles ensacado con visco. Info Pág. 52
Canapé **TUCÁN**, arcón de madera acabado bruma, tapa tapizada 3D crudo.

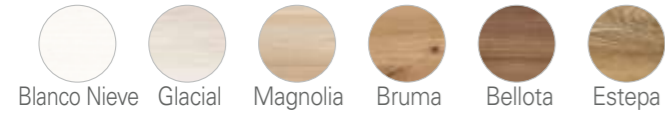

↑ **30cm.** ↓
Grosor colchón

Muelle ensacado 2 mm.

GRADO DE TRANSPIRACIÓN ●●●●○
GRADO DE FIRMEZA ●●●●●

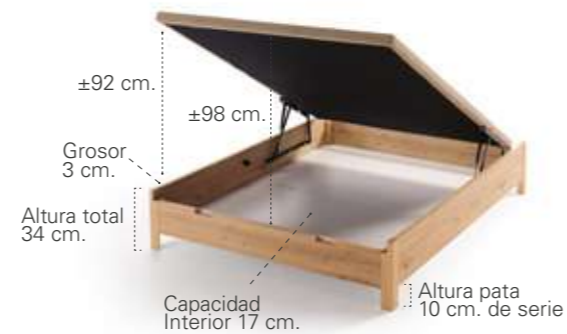

OPCIÓN PATAS pág. 56

PACK 20							
	80/90	105	120/135	140/150	160	180	200
180/190	783	845	990	1050	1127	1288	1448
200	825	895	1054	1117	1199	1372	1536

Tirador **EMBUTIDO DE SERIE**

Con patas **DE SERIE**

Bisagra doble pistón **+35 ptos.**
(Por defecto a partir 180cm)

Tablero multiperforado **DE SERIE**

Tapa partida **+125 ptos.**

Tejido antideslizante **DE SERIE**

A suelo **-25 ptos.**

Pack 21

COLCHÓN **BELLA**
CANAPÉ **TERUEL**

Colchón **BELLA**, núcleo de carcasa de muelles ensacado con visco. Info Pág. 52
Canapé **TERUEL**, arcón de madera acabado blanco, tapa tapizada 3D blanco.

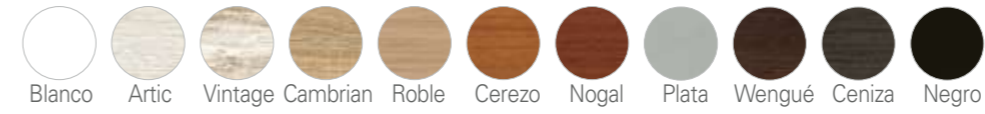

↑ **30cm.** ↓
Grosor colchón

Muelle ensacado 2 mm.

GRADO DE TRANSPIRACIÓN ●●●●○
GRADO DE FIRMEZA ●●●●●



PACK 21							
	80/90	105	120/135	140/150	160	180	200
180/190	789	850	984	1040	1107	1266	1405
200	836	901	1049	1107	1191	1354	1504

Bisagra doble pistón **+35 ptos.**
(Por defecto a partir 180cm)

A suelo **DE SERIE**

Tablero multiperforado **DE SERIE**

Tejido antideslizante **DE SERIE**

Tapa partida **+125 ptos.**

Con patas **SIN CARGO**

Pack 22

COLCHÓN BELLA CANAPÉ CONDOR

Colchón **BELLA**, núcleo de carcasa de muelles ensacado con visco.  Pág. 52
Canapé **CONDOR**, arcón de madera acabado bellota, tapa tapizada 3D chocolate.

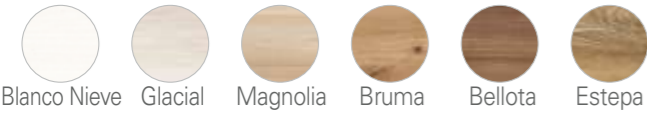

 **30cm.**
 Grosor colchón

 Muelle ensacado 2 mm.

GRADO DE TRANSPIRACIÓN ●●●●○
GRADO DE FIRMEZA ●●●●●



PACK 22							
	80/90	105	120/135	140/150	160	180	200
180/190	799	868	1009	1071	1148	1310	1480
200	842	917	1074	1138	1221	1395	1568

 Tirador EMBUTIDO DE SERIE
 A suelo DE SERIE
 Bisagra doble pistón +35 ptos. (Por defecto a partir 180cm)
 Tablero multiperforado DE SERIE
 Tapa partida +125 ptos.
 Tejido antideslizante DE SERIE

Pack 23

COLCHÓN BELLA CANAPÉ ESTAMBUL

Colchón **BELLA**, núcleo de carcasa de muelles ensacado con visco.  Pág. 52
Canapé **ESTAMBUL**, arcón de madera acabado blanco, tapa tapizada 3D blanco.

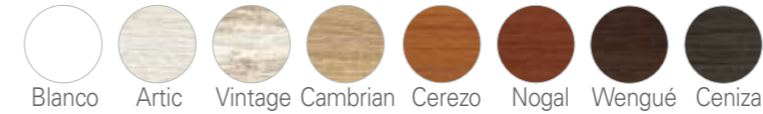

 **30cm.**
 Grosor colchón

 Muelle ensacado 2 mm.

GRADO DE TRANSPIRACIÓN ●●●●○
GRADO DE FIRMEZA ●●●●●



PACK 23					
	80/90	105	120/135	140/150	160
180/190	805	867	1027	1081	1188
200	849	921	1087	1147	1256

PACK 23 DUO			
	160	180	200
180/190	1481	1598	1726
200	1554	1685	1840

 Bisagra doble pistón +35 ptos.
 A suelo DE SERIE
 Tablero multiperforado DE SERIE
 Tejido antideslizante DE SERIE



Pack 24 | COLCHÓN BELLA CANAPÉ ELENA

Colchón **BELLA**, núcleo de carcasa de muelles ensacado con visco. [Info](#) Pág. 52
Canapé **ELENA**, arcón tapizado Tiago plata, tapa 3D.

↑
30cm.
↓
Grosor colchón

Muelle ensacado 2 mm.

GRADO DE TRANSPIRACIÓN ●●●●○

GRADO DE FIRMEZA ●●●●●

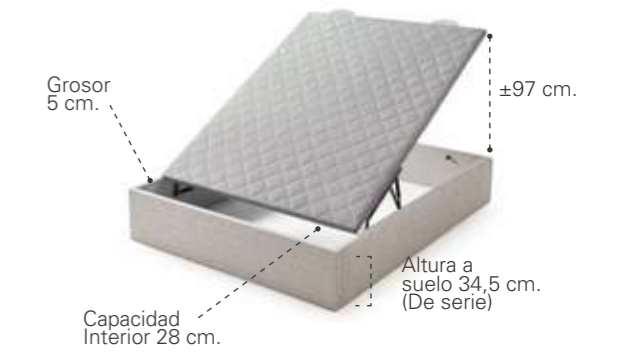

TIRADOR EN CROMO PLATA DE SERIE.
OPCIONAL EN NEGRO MATE.

PACK 24 - Acabado Serie 1							
	80/90	105	120/135	140/150	160	180	200
180/190	859	925	1074	1130	1216	1381	1558
200	903	972	1132	1194	1284	1460	1644

INCREMENTO SOBRE Serie 1	
S2	+ 35
S3	+ 75
S4	+ 105

A suelo DE SERIE

Bisagra doble pistón +35 pts. (Por defecto a partir 180cm)

Tablero multiperforado DE SERIE

Tapa partida +125 pts.

Tejido antideslizante DE SERIE

Pack 25

COLCHÓN **ARIEL**
BASE **SOMIER ARTICULADO**

Colchón **ARIEL**, núcleo HR perfilado con visco. Pág. 54
SOMIER ARTICULADO, 2 CUERPOSs, incluye patas.

↑
24cm.
↓
Grosor colchón

HR
Núcleo HR Ultra Plus

GRADO DE TRANSPIRACIÓN ●●●●○
GRADO DE FIRMEZA ●●●●○



PATAS CUADRADAS O CILINDRO INCLUIDAS.
PATAS NÓRDICA: +30 Ptos/juego

PACK 25								
	80/90 1 CUERPO	105 1 CUERPO	135 1 CUERPO	135 2 CUERPOS	150 1 CUERPO	150 2 CUERPOS	160 1 CUERPO	160 2 CUERPOS
180/190	813	869	1031	1540	1105	1606	1203	1758
200	865	927	1102	1648	1171	1720	1287	1882



Pata CUADRADA



Pata CILINDRO

Mando inalámbrico DE SERIE

Somieres sincronizados DE SERIE

Pack 26

COLCHÓN **ARIEL**
CANAPÉ **GOYA ARTICULADO**

Colchón **ARIEL**, núcleo HR perfilado con visco. Pág. 54
Canapé **GOYA ARTICULADO**, arcón de madera acabado artic, tapa articulada.

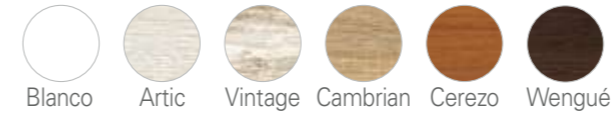

↑
24cm.
↓
Grosor colchón

HR
Núcleo HR Ultra Plus

GRADO DE TRANSPIRACIÓN ●●●●○
GRADO DE FIRMEZA ●●●●○



PACK 26								
	80/90 1 CUERPO	105 1 CUERPO	135 1 CUERPO	135 2 CUERPOS	140/150 1 CUERPO	140/150 2 CUERPOS	160 1 CUERPO	160 2 CUERPOS
180/190	1004	1069	1249	1720	1316	1792	1411	1921
200	1060	1130	1319	1825	1382	1898	1501	2040

PACK 26 TWIN			
	160 2 CUERPOS	180 2 CUERPOS	200 2 CUERPOS
180/190	2066	2083	2268
200	2184	2209	2352

Bisagra doble pistón +35 ptos. (Por defecto a partir 135cm)

A suelo DE SERIE

Mando inalámbrico DE SERIE

Somieres sincronizados DE SERIE

Con patas +30 ptos.

Pack 27

COLCHÓN **ARIEL**
CANAPÉ **ESTAMBUL ARTICULADO**

Colchón **ARIEL**, núcleo HR perfilado con visco. Pág. 54
Canapé **ESTAMBUL ARTICULADO**, arcón de madera acabado blanco, tapa articulada.

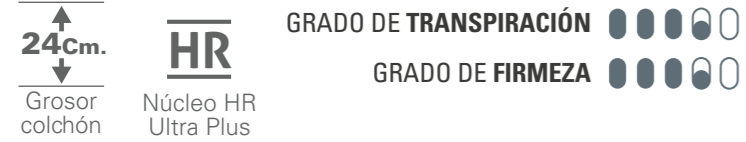
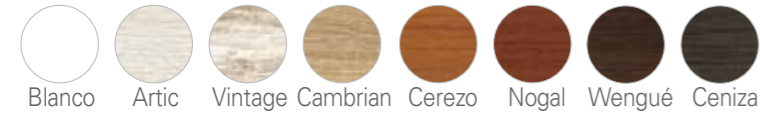

PACK 27								
	80/90 1 CUERPO	105 1 CUERPO	135 1 CUERPO	135 2 CUERPOS	140/150 1 CUERPO	140/150 2 CUERPOS	160 1 CUERPO	160 2 CUERPOS
180/190	1116	1186	1355	1868	1439	1941	1540	2071
200	1174	1247	1430	1979	1518	2052	1641	2221

PACK 27 TWIN			
	160 2 CUERPOS	180 2 CUERPOS	200 2 CUERPOS
180/190	2355	2355	2570
200	2485	2485	2632



Pack 28

COLCHÓN **ARIEL**
CANAPÉ **ELENA ARTICULADO**

Colchón **ARIEL**, núcleo HR perfilado con visco. Pág. 54
Canapé **ELENA ARTICULADO**, arcón tapizado Tiago plata, tapa articulada.

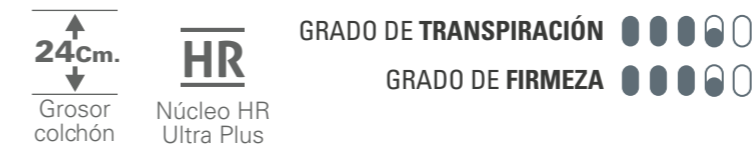

TIRADOR EN CROMO PLATA DE SERIE.
OPCIONAL EN NEGRO MATE.

PACK 28 - Acabado Serie 1										INCREMENTO SOBRE Serie 1		PACK 28 TWIN - Serie 1			INCREMENTO SOBRE Serie 1	
	80/90 1 CUERPO	105 1 CUERPO	135 1 CUERPO	135 2 CUERPOS	140/150 1 CUERPO	140/150 2 CUERPOS	160 1 CUERPO	160 2 CUERPOS	S2	+ 35	160 2 CUERPOS	180 2 CUERPOS	200 2 CUERPOS	S2	+ 70	
180/190	1151	1223	1441	2009	1528	2093	1620	2223	S3	+ 75	180/190	2396	2422	2631	S3	+ 150
200	1211	1288	1519	2121	1613	2217	1711	2357	S4	+ 105	200	2526	2555	2712	S4	+ 210



Pack 29

COLCHÓN **ALANA**
BASE **SOMIER ARTICULADO**

Colchón **ALANA**, núcleo de carcasa de muelles ensacado con visco.  Pág. 48
SOMIER ARTICULADO, 2 CUERPOSs, incluye patas.

↑ 24cm. ↓
Grosor colchón

 Muelle ensacado 2 mm.

GRADO DE TRANSPIRACIÓN ●●●●○
GRADO DE FIRMEZA ●●●○○



PATAS CUADRADAS O CILINDRO INCLUIDAS.
PATAS NÓRDICA: +30 Ptos/juego

PACK 29								
	80/90 1 CUERPO	105 1 CUERPO	135 1 CUERPO	135 2 CUERPOS	150 1 CUERPO	150 2 CUERPOS	160 1 CUERPO	160 2 CUERPOS
180/190	841	896	1079	1656	1155	1747	1258	1853
200	896	957	1155	1776	1226	1875	1348	1986



Pata CUADRADA



Pata CILINDRO

 Mando inalámbrico DE SERIE

 Somieres sincronizados DE SERIE

Pack 30

COLCHÓN **ALANA**
CANAPÉ **GOYA ARTICULADO**

Colchón **ALANA**, núcleo de carcasa de muelles ensacado con visco.  Pág. 48
Canapé **GOYA ARTICULADO**, arcón de madera acabado artic, tapa articulada.

○ ● ● ● ● ●
Blanco Artic Vintage Cambrian Cerezo Wengué

↑ 24cm. ↓
Grosor colchón

 Muelle ensacado 2 mm.

GRADO DE TRANSPIRACIÓN ●●●●○
GRADO DE FIRMEZA ●●●○○



PACK 30								
	80/90 1 CUERPO	105 1 CUERPO	135 1 CUERPO	135 2 CUERPOS	140/150 1 CUERPO	140/150 2 CUERPOS	160 1 CUERPO	160 2 CUERPOS
180/190	1041	1106	1309	1817	1379	1912	1480	1994
200	1101	1171	1385	1933	1451	2031	1578	2120

PACK 30 TWIN			
	160 2 CUERPOS	180 2 CUERPOS	200 2 CUERPOS
180/190	2165	2182	2362
200	2291	2317	2442

 Bisagra doble pistón +35 ptos. (Por defecto a partir 135cm)

 A suelo DE SERIE

 Mando inalámbrico DE SERIE

 Somieres sincronizados DE SERIE

 Con patas +30 ptos.

Pack 31 | COLCHÓN ALANA CANAPÉ ESTAMBUL ARTICULADO

Colchón **ALANA**, núcleo de carcasa de muelles ensacado con visco.  Pág. 48
Canapé **ESTAMBUL ARTICULADO**, arcón de madera acabado blanco, tapa articulada.

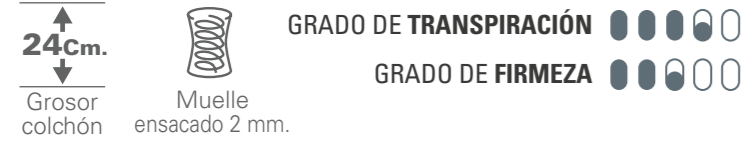
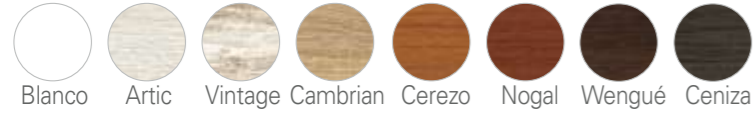

PACK 31								
	80/90 1 CUERPO	105 1 CUERPO	135 1 CUERPO	135 2 CUERPOS	140/150 1 CUERPO	140/150 2 CUERPOS	160 1 CUERPO	160 2 CUERPOS
180/190	1153	1224	1415	1963	1502	2061	1609	2144
200	1215	1288	1496	2083	1587	2184	1717	2301

PACK 31 TWIN			
	160 2 CUERPOS	180 2 CUERPOS	200 2 CUERPOS
180/190	2426	2426	2615
200	2563	2563	2692



Pack 32 | COLCHÓN ALANA CANAPÉ ELENA ARTICULADO

Colchón **ALANA**, núcleo de carcasa de muelles ensacado con visco.  Pág. 48
Canapé **ELENA ARTICULADO**, arcón tapizado Tiago plata, tapa articulada.

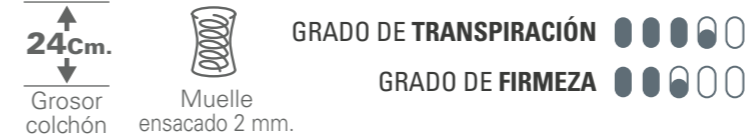

TIRADOR EN CROMO PLATA DE SERIE.
OPCIONAL EN NEGRO MATE.

PACK 32 - Acabado Serie 1										INCREMENTO SOBRE Serie 1		PACK 32 TWIN - Serie 1			INCREMENTO SOBRE Serie 1		
	80/90 1 CUERPO	105 1 CUERPO	135 1 CUERPO	135 2 CUERPOS	140/150 1 CUERPO	140/150 2 CUERPOS	160 1 CUERPO	160 2 CUERPOS	S2	+ 35		160 2 CUERPOS	180 2 CUERPOS	200 2 CUERPOS	S2	+ 70	
180/190	1187	1260	1500	2102	1590	2210	1689	2294	S3	+ 75		180/190	2466	2492	2685	S3	+ 150
200	1252	1329	1585	2231	1681	2346	1787	2435	S4	+ 105		200	2604	2634	2771	S4	+ 210



COLCHÓN Maurice

Núcleo HR. Doble cara.

1. **Tejido Stretch.**
Cara A. Suave y transpirable.
2. **Viscoelástica 40kg/m3 en el acolchado.**
Cara A. Gran adaptabilidad.
3. **Fibras Hipoalergénicas en los acolchados.**
Cara A. Mejora la circulación del aire.
4. **Soft Exclusive en los acolchados.**
Cara A. Extra de confort.
5. **Núcleo Flexcel Premium 25kg/m3.**
Alta densidad. Gran nivel de confort.
6. **Flexcel Ergofirm 25kg/m3 en el acolchado.**
Cara B. Extra de firmeza y estabilidad.
7. **Soft Exclusive en los acolchados.**
Cara B. Extra de confort.
8. **Fibras Hipoalergénicas en los acolchados.**
Cara B. Mejora la circulación del aire.
9. **Tejido Símil 3D Airfree.**
Cara B: Verano. Ultra transpirable.



COLCHÓN Maurice

GRADO DE TRANSPIRACIÓN ●●●●○

GRADO DE FIRMEZA ●●●○○



MAURICE							
	80/90	105	120/135	140/150	160	180	200
180/190	303	344	431	472	519	613	708
200	333	379	474	519	571	675	779

MAURICE VERSIÓN JUNIOR 18 CM.							
	80/90	105	120/135	140/150	160	180	200
180/190	207	238	293	327	360	425	491
200	227	258	322	360	396	468	540

26cm.
Grosor

Acolchado Continuo

Independencia de lechos

Ergonómico

Núcleo HR Ultra Plus

COLCHÓN Camille

Núcleo de muelles ensacados. Doble cara, una de ellas tejido simil 3D Airfree.

1. **Tejido Stretch.**
Cara A. Suave y transpirable.
2. **Viscoelástica 40kg/m3 en el acolchado.**
Cara A. Gran adaptabilidad.
3. **Fibras Hipoalergénicas en los acolchados.**
Cara A. Mejora la circulación del aire.
4. **Soft Exclusive en los acolchados.**
Cara A. Extra de confort.
5. **Plancha Flexcel Ergofirm 25kg/m3 en el núcleo.**
Cara A. Aporta estabilidad.
6. **Núcleo BS Spring 7 Zonas.**
1000 muelles. Adaptabilidad selectiva. Independencia de lechos. Alta firmeza. Calibre: 2mm.
7. **Box Perimetral espuma extrafirme 30kg/m3**
8. **Plancha Flexcel Ergofirm 25kg/m3 en el núcleo.**
Cara B. Aporta estabilidad.
9. **Flexcel Ergofirm en el acolchado.**
Cara B. Extra de firmeza y estabilidad.
10. **Soft Exclusive en los acolchados.**
Cara B. Extra de confort.
11. **Fibras Hipoalergénicas en los acolchados.**
Cara B. Mejora la circulación del aire.
12. **Tejido Símil 3D Airfree.**
Cara B: Verano. Ultra transpirable.



CAMILLE							
	80/90	105	120/135	140/150	160	180	200
180/190	313	355	444	479	527	622	718
200	345	390	489	527	579	685	790

CAMILLE VERSIÓN JUNIOR 18 CM.							
	80/90	105	120/135	140/150	160	180	200
180/190	241	269	327	362	398	470	543
200	265	296	360	398	438	517	597

COLCHÓN Camille

GRADO DE TRANSPIRACIÓN ●●●●○

GRADO DE FIRMEZA ●●●●○



26cm.
Grosor

Acolchado Continuo

Independencia de lechos

Ergonómico

Muelle ensacado 2 mm.

COLCHÓN Aura

Núcleo HR. Una cara.

1. Tejido Stretch con hilo GRS.

Cara A. Más sostenible, con hilos reciclados.

2. Viscoelástica 40kg/m3 en el acolchado.

Cara A. Gran adaptabilidad.

3. Fibras Hipoalergénicas en los acolchados.

Cara A. Mejora la circulación del aire.

4. Flexcel Ergofirm 25kg/m3 en el acolchado.

Cara A. Extra de firmeza y estabilidad.

5. 4cm Gel Soft Premium en el núcleo.

Cara A. Alivio de presión. Sensación antigraedad. Efecto gel.

6. Núcleo Flexcel Adapt 35kg/m3

Alta durabilidad y capacidad de recuperación. Compatible con pesos XXL.

7. Soft Exclusive en el acolchado.

Cara B. Extra de confort

8. Fibras Hipoalergénicas en los acolchados.

Cara B. Mejora la circulación del aire.

9. Tejido 3D Airfree Premium.

Cara B. Dispersa el calor.



COLCHÓN Aura

GRADO DE TRANSPIRACIÓN ●●●●○

GRADO DE FIRMEZA ●●●●○



AURA							
	80/90	105	120/135	140/150	160	180	200
180/190	389	441	548	603	663	784	904
200	428	485	602	663	729	862	995



COLCHÓN Thiago

Núcleo de muelles ensacados. Doble cara, una de ellas tejido NOAS COOL.

1. **Tejido Stretch X-Cool.**
Cara A: Verano. Tacto frío.
2. **Viscotecnology 45kg/m3 en los acolchados.**
Cara A. Con Carbono, Grafeno y Gel.
3. **Soft Exclusive en los acolchados.**
Cara A. Extra de confort.
4. **Flexcel Ergofirm 25kg/m3 en el acolchado.**
Cara A. Extra de firmeza y estabilidad.
5. **Plancha 1,5cm Flexcel Ergofirm 25kg/m3 en el núcleo.**
Cara A. Aporta estabilidad.
6. **Núcleo BS Spring 7 Zonas.**
1000 muelles. Adaptabilidad selectiva. Independencia de lechos. Alta firmeza. Calibre: 2mm.
7. **Box Perimetral espuma extrafirme 30kg/m3**
8. **Plancha 1,5cm Flexcel Ergofirm 25kg/m3 en el núcleo.**
Cara A. Aporta estabilidad.
9. **Fibras Hipoalergénicas en el acolchado.**
Cara B. Mejora la circulación del aire.
10. **Soft Exclusive en los acolchados.**
Cara B. Extra de confort.
11. **Viscoelástica 40kg/m3 en el acolchado.**
Cara B. Confort y adaptabilidad.
12. **Tejido Stretch.**
Cara B: Invierno. Suave y transpirable.



THIAGO							
	80/90	105	120/135	140/150	160	180	200
180/190	400	448	568	617	678	802	925
200	440	493	625	678	746	882	1017

COLCHÓN Thiago

GRADO DE TRANSPIRACIÓN ●●●●●

GRADO DE FIRMEZA ●●●●○



↑
28cm.
↓
Grosor

Acoplado
Tapa-Tapa

Independencia
de lechos

Ergonómico

Muelle
ensacado 2 mm.

Tejido
NOAS COOL

COLCHÓN Alana

Núcleo de muelles ensacados. Una cara.

- 1. Tejido Stretch con Algodón.**
Cara A. Más fresco.
- 2. 5cm Viscoelástica 45kg/m3 en el núcleo.**
Cara A. Adaptabilidad y ergonomía.
- 3. 4cm Gel Soft Premium 28kg/m3 en el núcleo.**
Cara A. Alivio de presión. Sensación antigraavedad. Efecto gel.
- 4. 4cm Flexcel Extrafirm en el núcleo.**
Cara A. Extra de firmeza y estabilidad.
- 5. Núcleo Muelle Ensacado Monozona. Articulable.**
800 muelles. Adaptabilidad selectiva. Independencia de lechos. Alta firmeza. Calibre: 2mm.
- 6. Box Perimetral 30kg/m3 perfilado.**
- 7. 1,5 Flexcel Ergofirm 25kg/m3 en el núcleo**
Cara B. Aporta estabilidad
- 8. Tejido 3D Airfree.**
Cara B. Controla la humedad.



ALANA

	80/90	105	120/135	140/150	160	180	200
180/190	403	451	579	630	693	819	946
200	443	496	637	693	763	901	1040

ALANA GEMELAR

	135	150	160	180	200
180/190	917	967	987	1014	1141
200	1008	1063	1085	1112	1173

COLCHÓN Alana

GRADO DE TRANSPIRACIÓN ●●●●○

GRADO DE FIRMEZA ●●●○○



24cm.
Grosor

Independencia de lechos

Ergonómico

Muelle ensacado 2 mm.

Eric COLCHÓN

Núcleo de muelles ensacados. Doble cara.

1. Tejido Stretch con hilo GRS.

Ambas caras. Más sostenible, con hilos reciclados.

2. Viscotechnology 45kg/m3 en los acolchados.

Ambas caras. Con Carbono, Grafeno y Gel.

3. Soft Exclusive en los acolchados.

Ambas caras. Extra de confort.

4. Flexcel Ergofirm 25kg/m3 en el acolchado.

Ambas caras. Extra de firmeza y estabilidad.

5. Planchas 2,5cm Flexcel Ergofirm 26kg/m3 en el núcleo.

Ambas caras. Aporta estabilidad.

6. Núcleo BS Spring 7 Zonas.

1000 muelles. Adaptabilidad selectiva. Independencia de lechos. Alta firmeza. Calibre: 2mm.

7. Box Perimetral espuma extrafirme 30kg/m3



ERIC	80/90	105	120/135	140/150	160	180	200
180/190	444	499	620	661	727	860	992
200	489	549	682	727	800	946	1091

Eric COLCHÓN

GRADO DE TRANSPIRACIÓN ●●●●○

GRADO DE FIRMEZA ●●●●●



Grosor



Acolchado Tapa-Tapa



Independencia de lechos



Ergonómico



Muelle ensacado 2 mm.

Bella

COLCHÓN

Núcleo de muelles ensacados. Doble cara.

1. **Tejido Damastretch con Viscosa.**
Ambas caras. Más fresco gracias a las fibras naturales.
2. **Viscoelástica 40kg/m3 en el acolchado.**
Ambas caras. Gran adaptabilidad.
3. **Fibras Hipoalergénicas en los acolchados.**
Ambas caras. Mejora la circulación del aire.
4. **Doble capa Flexcel Ergofirm 25kg/m3 en el acolchado.**
Ambas caras. Extra de firmeza y estabilidad.
5. **Planchas 3cm Flexcel Ergofirm 25kg/m3 en el núcleo.**
Ambas caras. Aporta estabilidad.
6. **Núcleo BS Spring 7 Zonas.**
1000 muelles. Adaptabilidad selectiva. Independencia de lechos. Alta firmeza. Calibre: 2mm.
7. **Box Perimetral espuma extrafirm 30kg/m3**



BELLA							
	80/90	105	120/135	140/150	160	180	200
180/190	468	527	661	710	781	922	1064
200	515	580	727	781	859	1015	1171

Bella

COLCHÓN

GRADO DE TRANSPIRACIÓN ●●●●○

GRADO DE FIRMEZA ●●●●●



30cm.
Grosor

Acolchado Tapa-Tapa

Independencia de lechos

Ergonómico

Muelle ensacado 2 mm.

Ariel COLCHÓN

Núcleo HR. Una cara.

- 1. Tejido Stretch con Algodón.**
Cara A. Más fresco.
- 2. 5cm Viscoelástica en el núcleo.**
Cara A. Adaptabilidad y ergonomía.
- 3. 4cm Flexcel Extrafirm 30kg/m3 en el núcleo.**
Cara A. Extra de firmeza y estabilidad.
- 4. Núcleo Flexcel Premium 26kg/m3.**
Flexible y ergonómico. Perfilado para su correcta adaptación a camas articuladas.
- 5. Tejido 3D Airfree.**
Cara B. Controla la humedad.



ARIEL	80/90	105	120/135	140/150	160	180	200
180/190	358	406	506	555	610	721	832
200	394	447	557	610	671	793	915

ARIEL GEMELAR	135	150	160	180	200
180/190	800	823	900	927	1040
200	880	906	990	1012	1100

COLCHÓN Ariel

GRADO DE TRANSPIRACIÓN ●●●●○

GRADO DE FIRMEZA ●●●●○



Grosor



Independencia de lechos



Ergonómico



Núcleo HR Ultra Plus

OPCIÓN PATAS PARA PACKS CON CANAPÉS TUCÁN, FILIPO y NINFA



Pata CARLA
Cromo plata

Pata CARLA
Cromo negro

Pata CARLA
Negro mate

• Altura pata CARLA: 13,5 cm.



Pata TACÓN
Cromo PLATA

Pata TACÓN
Cromo NEGRO

Pata TACÓN
Negro mate

• Altura pata TACÓN: 12 cm.



Pata ROMA
Cromo plata

Pata ROMA
Negro mate

• Altura pata ROMA: 13,5 cm.



Pata OLIMPIA
Madera

Acabados pata Olimpia



• Altura pata OLIMPIA: 12 cm.





Pol. La Herrada C/ Príncipe de Asturias, Parc. 7-D, Naves 8 y 9
Apdo. Correos 592 - 30510 YECLA (Murcia) España
Telf.: 968 75 25 43 - Fax: 968 79 16 82
info@noasdescanso.com - pedidos@noasdescanso.com